

Cascadable Silicon Bipolar MMIC Amplifier

Technical Data

MSA-0685

Features

- **Cascadable 50 Ω Gain Block**
- **Low Operating Voltage:**
3.5 V Typical V_d
- **3 dB Bandwidth:**
DC to 0.8 GHz
- **High Gain:**
18.5 dB Typical at 0.5 GHz
- **Low Noise Figure:**
3.0 dB Typical at 0.5 GHz
- **Low Cost Plastic Package**

Description

The MSA-0685 is a high performance silicon bipolar Monolithic Microwave Integrated Circuit (MMIC) housed in a low cost

plastic package. This MMIC is designed for use as a general purpose 50 Ω gain block. Typical applications include narrow and broad band IF and RF amplifiers in commercial and industrial applications.

The MSA-series is fabricated using HP's 10 GHz f_T , 25 GHz f_{MAX} , silicon bipolar MMIC process which uses nitride self-alignment, ion implantation, and gold metallization to achieve excellent performance, uniformity and reliability. The use of an external bias resistor for temperature and current stability also allows bias flexibility.

85 Plastic Package

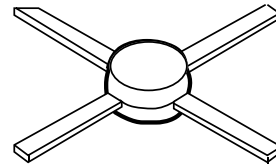

Typical Biasing Configuration

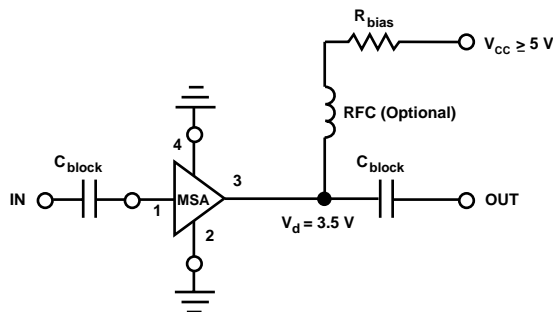

MSA-0685 Absolute Maximum Ratings

Parameter	Absolute Maximum ^[1]
Device Current	50 mA
Power Dissipation ^[2,3]	200 mW
RF Input Power	+13 dBm
Junction Temperature	150°C
Storage Temperature	-65 to 150°C

Thermal Resistance^{[2,4]:}

$$\theta_{jc} = 110^{\circ}\text{C}/\text{W}$$

Notes:

1. Permanent damage may occur if any of these limits are exceeded.
2. $T_{\text{CASE}} = 25^{\circ}\text{C}$.
3. Derate at $9.1 \text{ mW}/^{\circ}\text{C}$ for $T_{\text{C}} > 128^{\circ}\text{C}$.
4. See MEASUREMENTS section “Thermal Resistance” for more information.

Electrical Specifications^[1], $T_{\text{A}} = 25^{\circ}\text{C}$

Symbol	Parameters and Test Conditions: $I_{\text{d}} = 16 \text{ mA}$, $Z_{\text{o}} = 50 \Omega$	Units	Min.	Typ.	Max.
G_{P}	Power Gain ($ S_{21} ^2$)	dB	17.0	$f = 0.1 \text{ GHz}$	20.0
				$f = 0.5 \text{ GHz}$	18.5
ΔG_{P}	Gain Flatness	dB		± 0.7	
$f_{3 \text{ dB}}$	3 dB Bandwidth	GHz		0.8	
VSWR	Input VSWR			1.5:1	
	Output VSWR			1.4:1	
NF	50 Ω Noise Figure	dB		3.0	
$P_{1 \text{ dB}}$	Output Power at 1 dB Gain Compression	dBm		2.0	
IP_3	Third Order Intercept Point	dBm		14.5	
t_{D}	Group Delay	psec		200	
V_{d}	Device Voltage	V	2.8	3.5	4.2
dV/dT	Device Voltage Temperature Coefficient	mV/ $^{\circ}\text{C}$		-8.0	

Note:

1. The recommended operating current range for this device is 12 to 25 mA. Typical performance as a function of current is on the following page.

MSA-0685 Typical Scattering Parameters ($Z = 50 \Omega$, $T_A = 25^\circ\text{C}$, $I_d = 16 \text{ mA}$)

Freq. GHz	S ₁₁		S ₂₁			S ₁₂			S ₂₂		k
	Mag	Ang	dB	Mag	Ang	dB	Mag	Ang	Mag	Ang	
0.1	.04	171	20.1	10.09	171	-22.5	.075	5	.04	-30	1.04
0.2	.02	-180	29.8	9.75	161	-22.4	.076	10	.05	-56	1.04
0.3	.02	-143	19.4	9.38	153	-22.2	.077	15	.07	-76	1.05
0.4	.03	-113	19.1	8.99	145	-21.8	.081	17	.08	-91	1.04
0.5	.05	-105	18.7	8.57	138	-21.3	.086	21	.10	-104	1.04
0.6	.07	-101	18.2	8.14	131	-20.7	.092	25	.11	-116	1.03
0.8	.10	-111	17.3	7.32	119	-19.7	.103	28	.13	-134	1.01
1.0	.13	-118	16.4	6.57	107	-18.8	.115	28	.14	-150	0.99
1.5	.21	-140	14.1	5.06	84	-17.1	.140	28	.15	180	1.00
2.0	.29	-163	12.0	3.98	65	-15.8	.163	26	.16	157	1.02
2.5	.34	-176	10.3	3.26	55	-15.2	.174	28	.16	150	1.06
3.0	.41	169	8.7	2.71	42	-14.8	.181	25	.15	143	1.10
3.5	.46	157	7.2	2.31	30	-14.2	.194	22	.13	144	1.11
4.0	.49	146	6.1	2.01	18	-13.8	.203	20	.10	156	1.13
4.5	.52	135	5.0	1.77	7	-13.4	.215	17	.09	173	1.14
5.0	.54	123	4.1	1.60	-3	-12.9	.226	15	.09	-178	1.14

Note:

1. A model for this device is available in the DEVICE MODELS section.

Typical Performance, $T_A = 25^\circ\text{C}$

(unless otherwise noted)

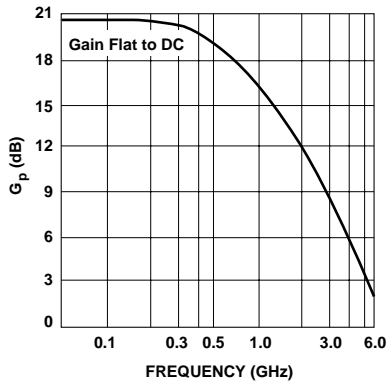

Figure 1. Typical Power Gain vs. Frequency, $T_A = 25^\circ\text{C}$, $I_d = 16 \text{ mA}$.

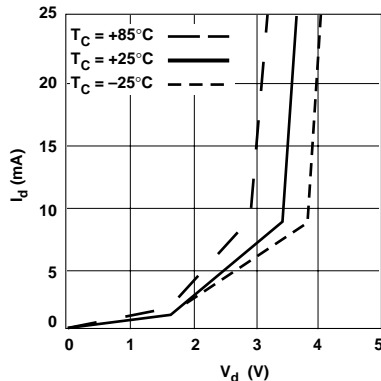

Figure 2. Device Current vs. Voltage.

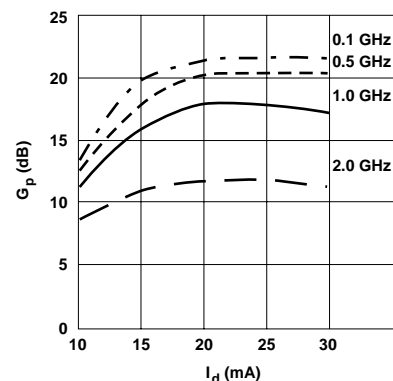

Figure 3. Power Gain vs. Current.

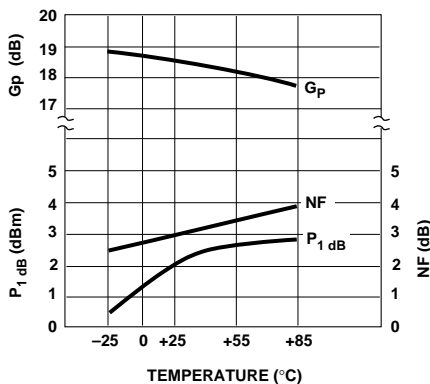

Figure 4. Output Power at 1 dB Gain Compression, NF and Power Gain vs. Case Temperature, $f = 0.5 \text{ GHz}$, $I_d = 16 \text{ mA}$.

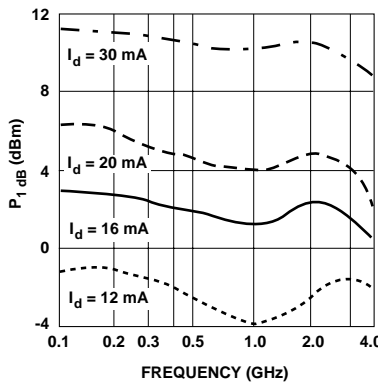

Figure 5. Output Power at 1 dB Gain Compression vs. Frequency.

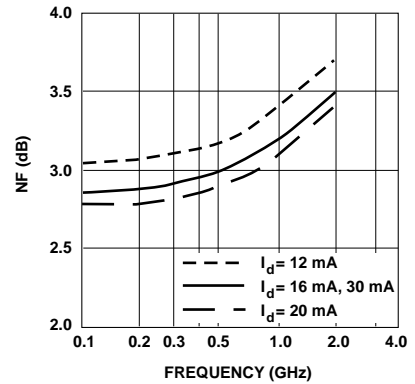
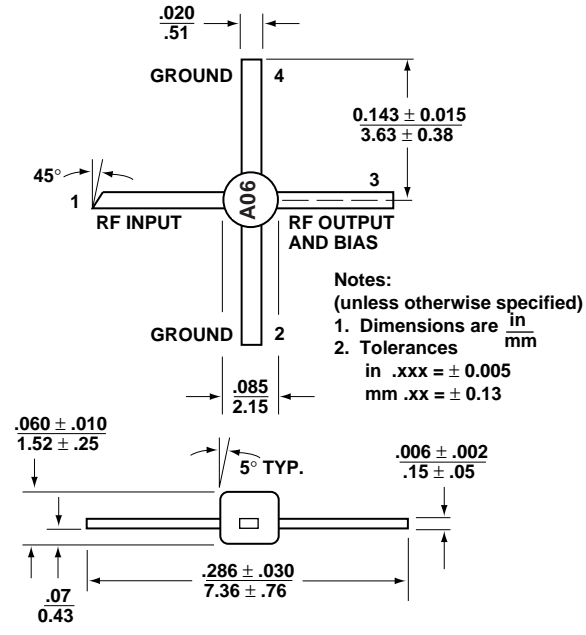

Figure 6. Noise Figure vs. Frequency.

85 Plastic Package Dimensions



This datasheet has been download from:

www.datasheetcatalog.com

Datasheets for electronics components.