



Product Description

RFMD's SXB4089Z amplifier is a high efficiency InGaP/GaAs heterojunction bipolar transistor (HBT) MMIC housed in low-cost, surface-mountable plastic package. These amplifiers are specially designed for use as driver devices for infrastructure equipment in the 400MHz to 2500MHz cellular, ISM, WLL, PCS, WCDMA applications. Its high linearity makes it an ideal choice for multi-carrier as well as digital applications.

Optimum Technology Matching® Applied

- GaAs HBT
- GaAs MESFET
- InGaP HBT
- SiGe BiCMOS
- Si BiCMOS
- SiGe HBT
- GaAs pHEMT
- Si CMOS
- Si BJT
- GaN HEMT
- RF MEMS

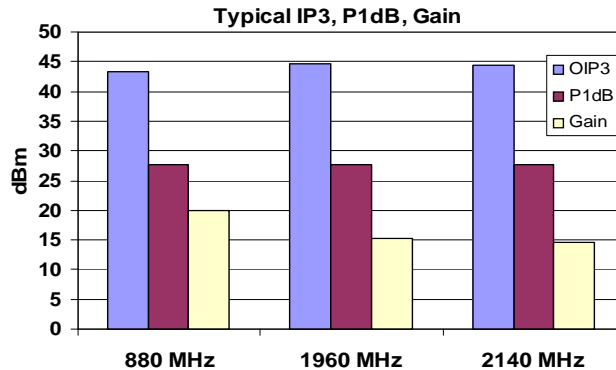

Features

- On-Chip Active Bias Control, Single 5V Supply
- High Output 3rd Order Intercept:
- +45dBm Typ.
- High P1dB: +28dBm Typ.
- High Gain: +20dB at 880MHz
- Low R_{TH}: 25 °C/W Typ.
- Robust 2000V ESD, Class 2

Applications

- WCDMA, PCS, Cellular Systems
- Multi-Carrier Applications

Parameter	Specification			Unit	Condition
	Min.	Typ.	Max.		
Small Signal Gain	18.0	20.0	22.0	dBm	880MHz
		15.0		dBm	1960MHz
	12.5	14.0	15.5	dBm	2140MHz
Output Power at 1dB Compression,		27.5		dBm	880MHz
		27.5		dBm	1960MHz
	26.0	27.5		dBm	2140MHz
Output Third Order Intercept Point	41.5	43.5		dBm	880MHz
		44.5		dBm	1960MHz
	42.5	44.5		dBm	2140MHz
Noise Figure		5.6		dB	880MHz
		3.3		dB	1960MHz
		3.3		dB	2140MHz
Input VSWR		1.3:1	2.0:1		880MHz
		1.3:1			1960MHz
		1.3:1			2140MHz
Device Operating Voltage	4.75	5.0	5.25	V	
Device Operating Current	235.0	265.0	330.0	mA	
Thermal Resistance		25.3		°C/W	junction to backside

Test Conditions: T_A = 25 °C, Z₀ = 50Ω, Measured in Application Circuit, P_{OUT} per tone = +11dBm, Tone Spacing = 1MHz

Absolute Maximum Ratings

Parameter	Rating	Unit
Max Device Current (I_D)	500	mA
Max Device Voltage (V_D)	6	V
Max RF Input Power	1.8	dBm
Max Dissipated Power	2	W
Max Junction Temperature (T_J)	165	°C
Operating Temperature Range (T_L)	-40 to + 85	°C
Max Storage Temperature	150	°C
ESD Rating - Human Body Model (HBM)	Class 2	
Moisture Sensitivity Level	MSL2	



Caution! ESD sensitive device.

Exceeding any one or a combination of the Absolute Maximum Rating conditions may cause permanent damage to the device. Extended application of Absolute Maximum Rating conditions to the device may reduce device reliability. Specified typical performance or functional operation of the device under Absolute Maximum Rating conditions is not implied.

The information in this publication is believed to be accurate and reliable. However, no responsibility is assumed by RF Micro Devices, Inc. ("RFMD") for its use, nor for any infringement of patents, or other rights of third parties, resulting from its use. No license is granted by implication or otherwise under any patent or patent rights of RFMD. RFMD reserves the right to change component circuitry, recommended application circuitry and specifications at any time without prior notice.



RFMD Green: RoHS compliant per EU Directive 2002/95/EC, halogen free per IEC 61249-2-21, < 1000ppm each of antimony trioxide in polymeric materials and red phosphorus as a flame retardant, and <2% antimony in solder.

Operation of this device beyond any one of these limits may cause permanent damage. For reliable continuous operation, the device voltage and current must not exceed the maximum operating values specified in the table on page one. Bias Conditions should also satisfy the following expression: $I_D V_D < (T_J - T_L) / R_{TH, j} - I$ and $T_L = T_{LEAD}$

880 MHz Application Circuit Data, $V_{CC}=5V$, $I_D=270mA$

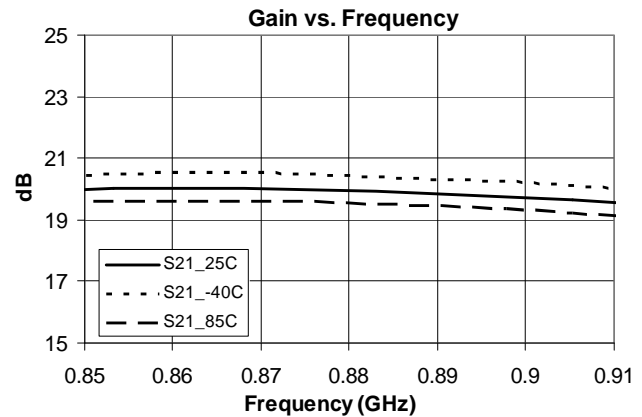
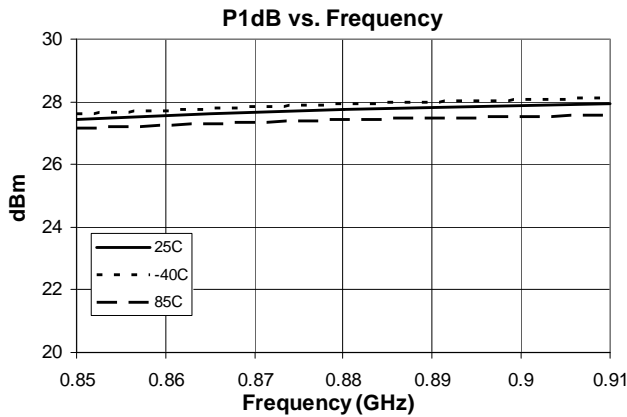

880 MHz Application Circuit Data, $V_{CC}=5V$, $I_D=270mA$

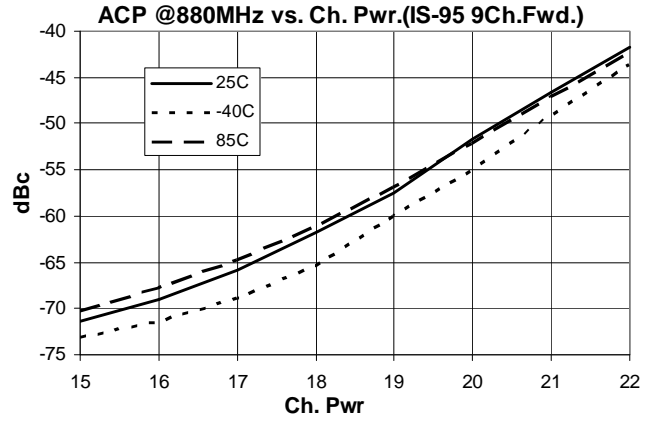
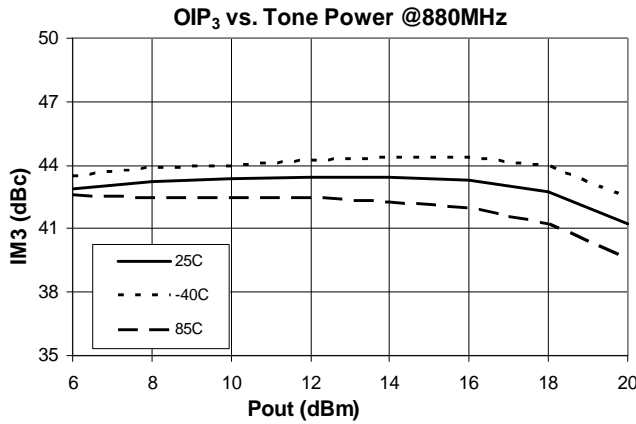
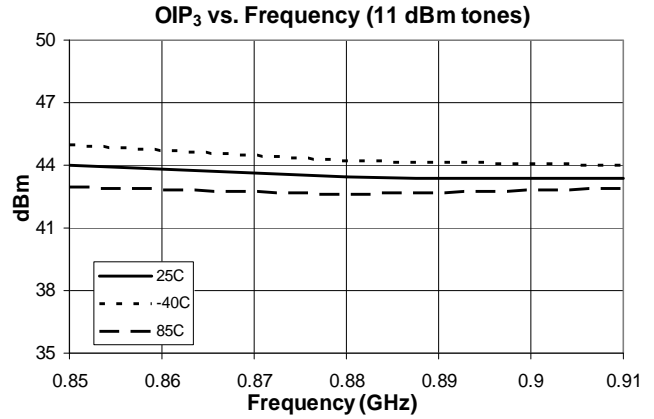
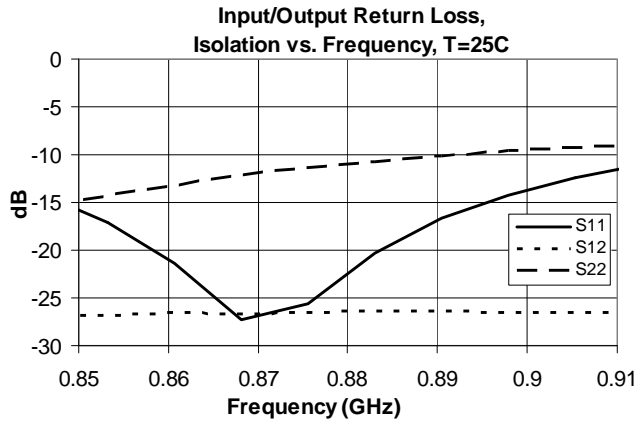

1960 MHz Application Circuit Data, $V_{CC}=5V$, $I_D=270mA$

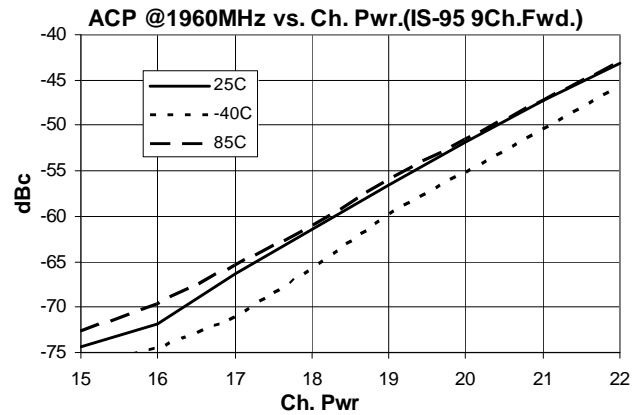
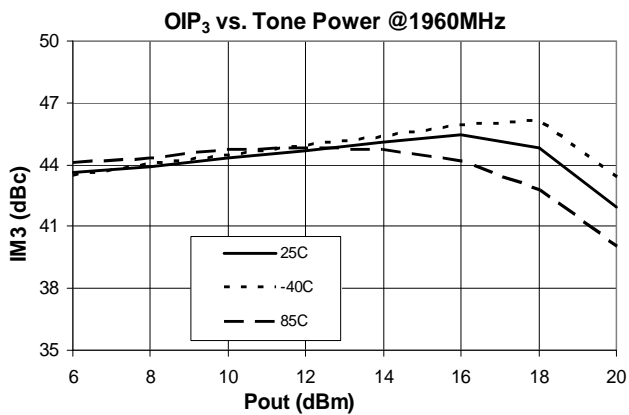
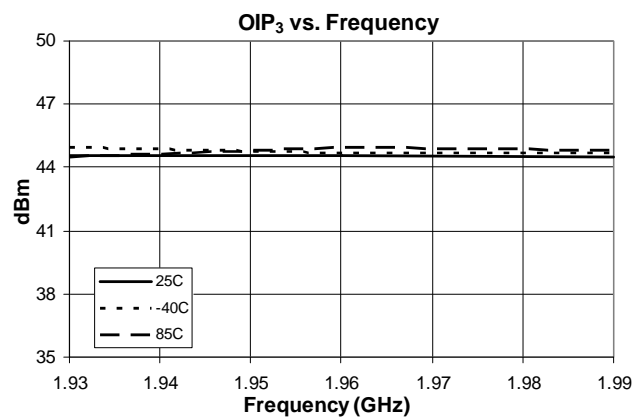
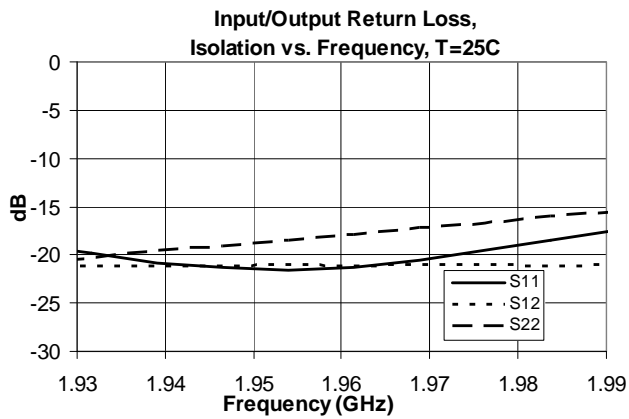
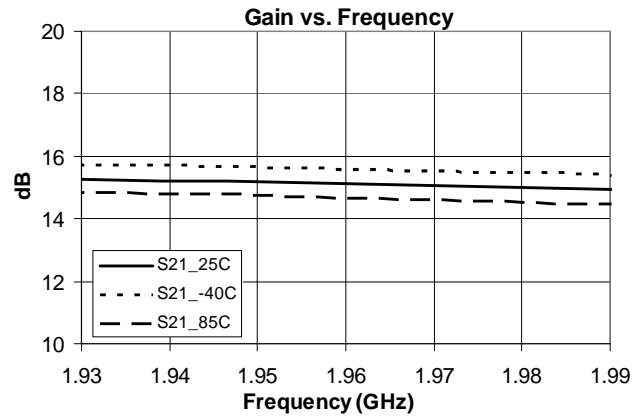
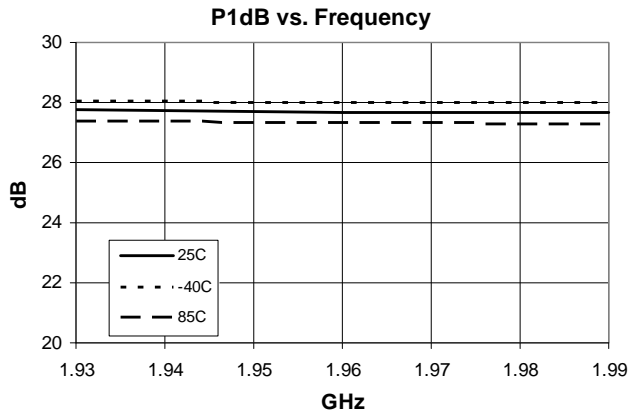

2140 MHz Application Circuit Data, $V_{CC}=5V, I_D=270mA$

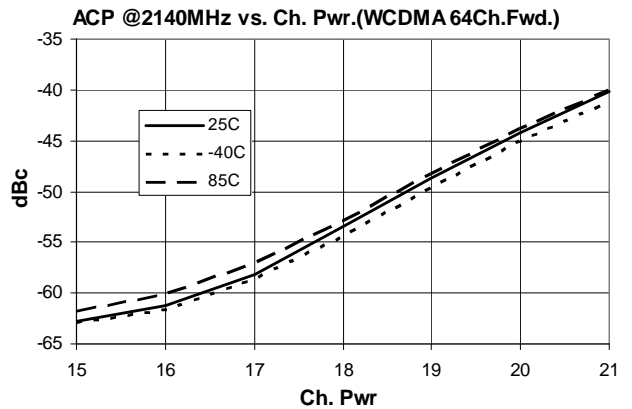
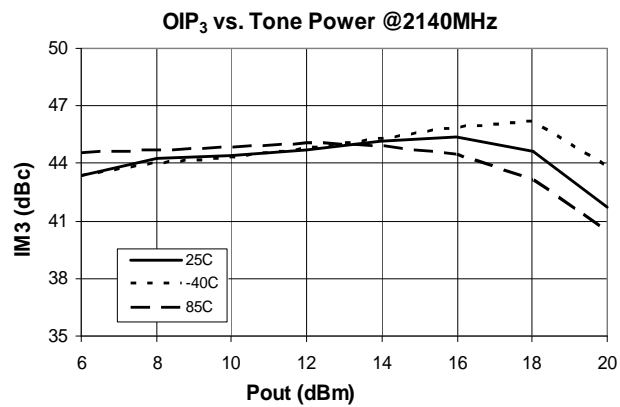
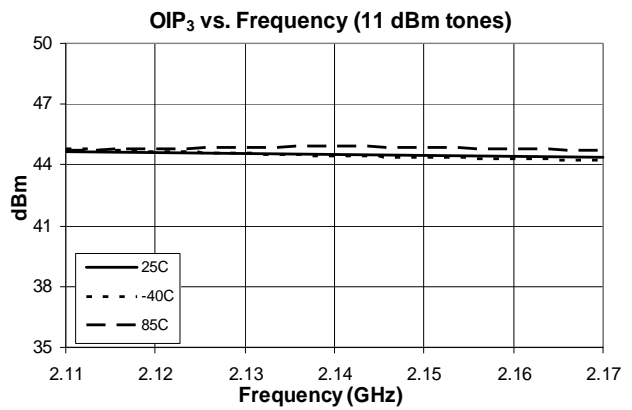
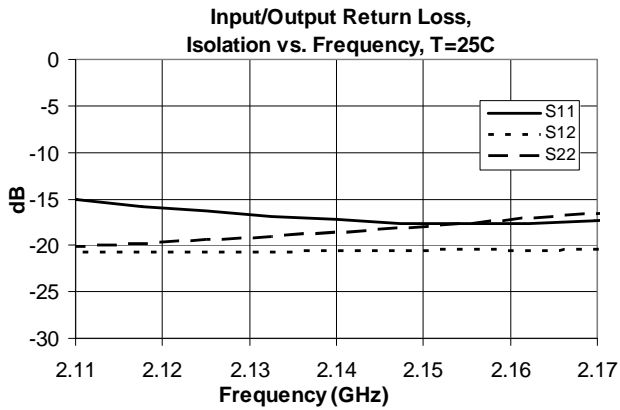
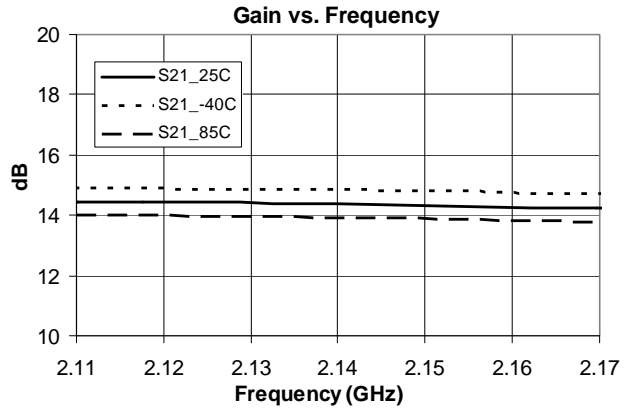
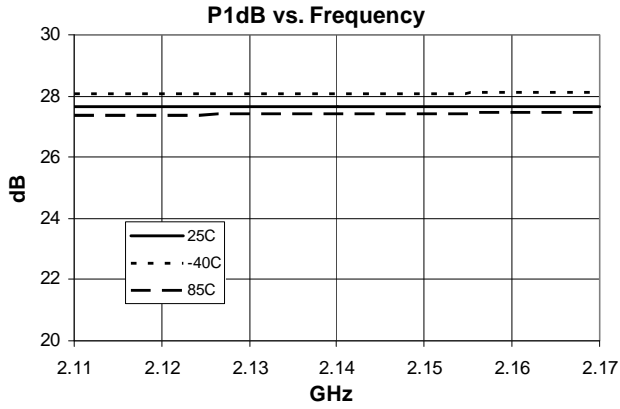

Pin Names and Descriptions

Pin	Name	Description
1	RF IN	RF input pin. This pin requires the use of an external DC blocking capacitor chosen for the frequency of operation.
2, 4	GND	Connection to ground. Use via holes for best performance to reduce lead inductance as close to ground leads as possible.
3	RF OUT/Bias	RF output and bias pin. DC voltage is present on this pin, therefore a DC blocking capacitor is necessary for proper operation.

Suggested Pad Layout

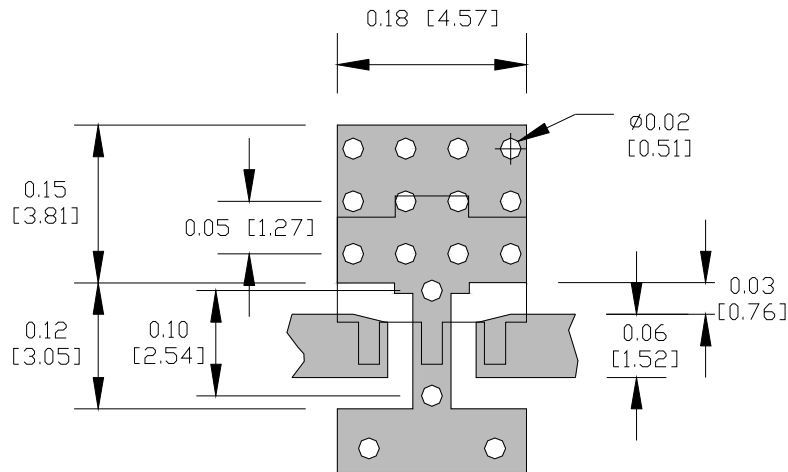

Package Drawing

Dimensions in inches (millimeters)

Refer to drawing posted at www.rfmd.com for tolerances.

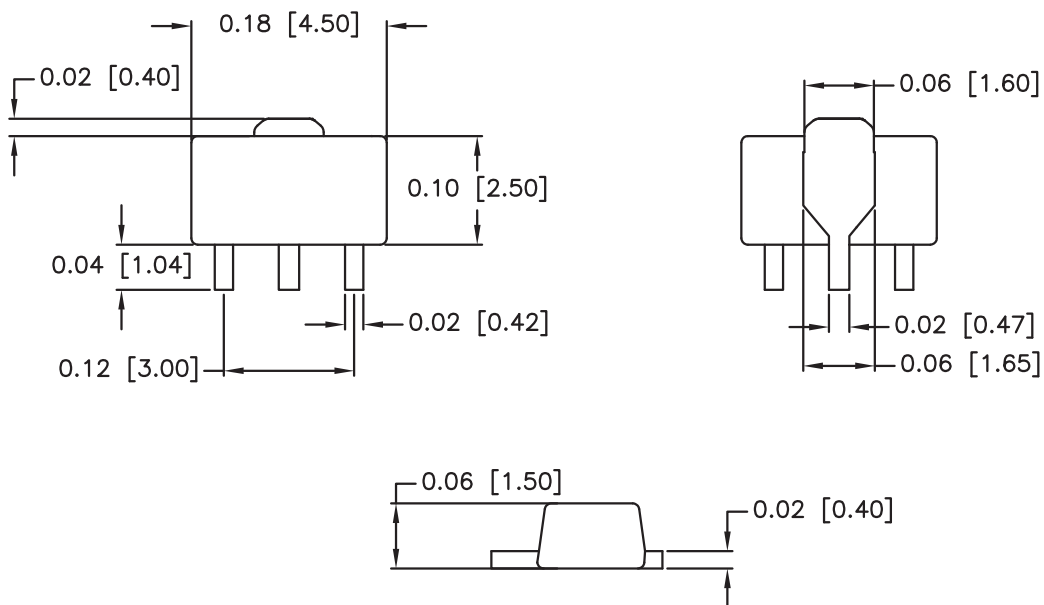

880MHz Application Schematic

880 MHz Demo Board

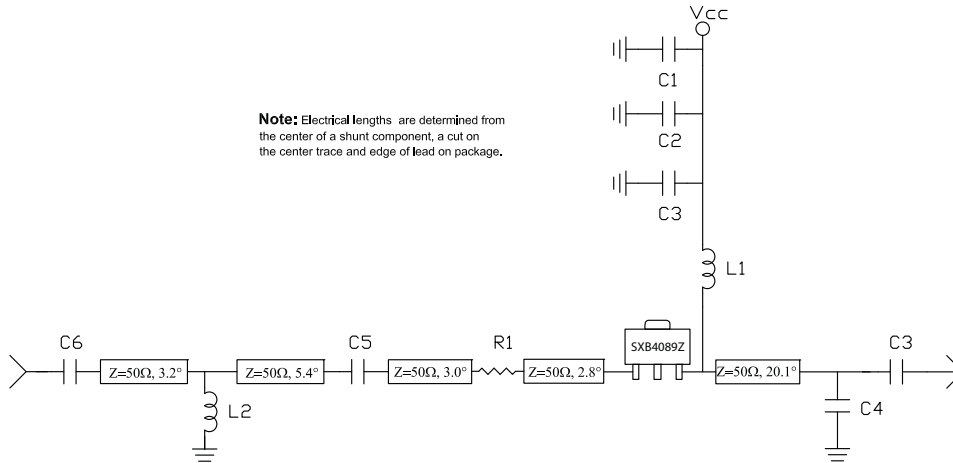

Bill of Materials

C1	1x	TAJB104KLRH	Rohm	0.1uF
C2	1x	MCH185C102KK	Rohm	1000pF
C3	2x	MCH185A680JK	Rohm	68pF
C4	1x	MCH185A3R9CK	Rohm	3.9pF
C5	1x	MCH185C4R7CK	Rohm	4.7pF
C6	1x	MCH185C120CK	Rohm	12pF
L1	1x	0805HQ-	Coilcraft	48nH
L2	1x	LL1608-FS2N7J	Toko	2.7nH
R1	1x	0603-	Rohm	1ohm
RF1	2x	142-0701-846	Johnson Comp.	
		Heat sink	EEF-101216	
PCB		ECB-101499	C	

880MHz Evaluation Board Layout

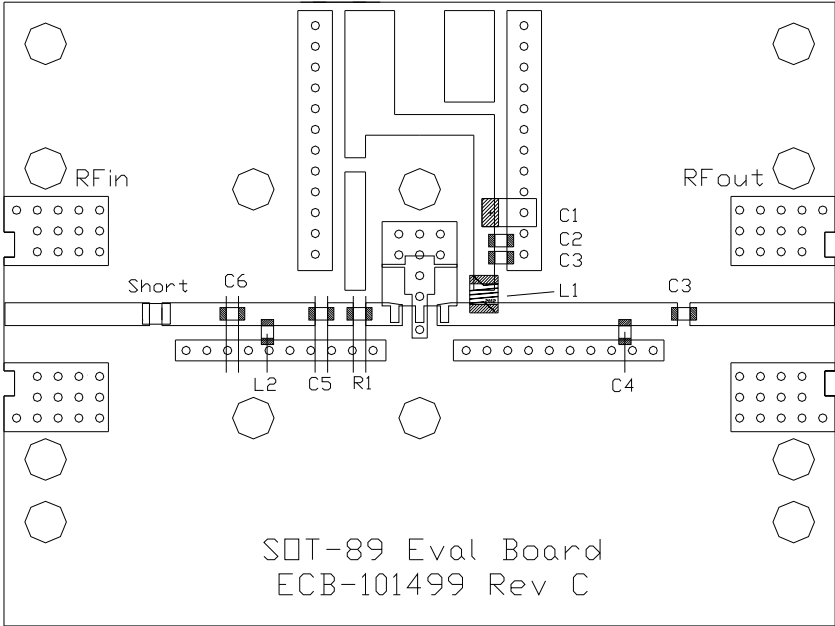

1960MHz Application Schematic

1960 MHz Demo Board

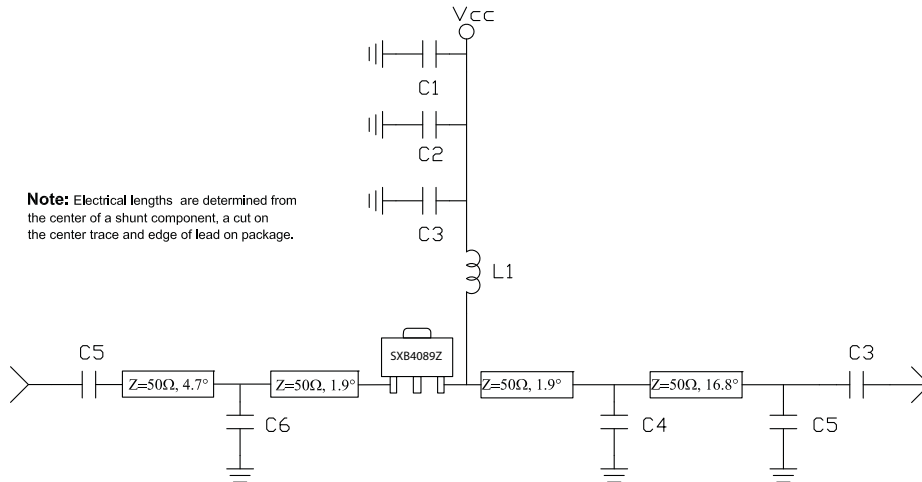

Bill of Materials

C1	1x	TAJB104KLRH	Rohm	0.1uF
C2	1x	MCH185C102KK	Rohm	1000pF
C3	2x	MCH185A220JK	Rohm	22pF
C4	1x	MCH185A1R5CK	Rohm	1.5pF
C5	2x	MCH185A1R2CK	Rohm	1.2pF
C6	1x	MCH185A1R8CK	Rohm	1.8pF
L1	1x	0805HQ-	Coilcraft	20nH
RF1	2x	142-0701-846	Johnson Comp.	
		Heat sink	EEF-101216	
PCB		ECB-101499	C	

1960MHz Evaluation Board Layout

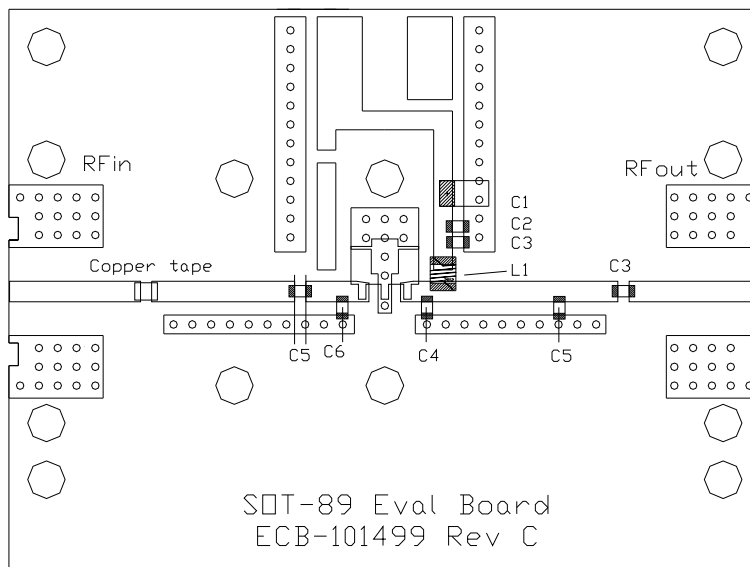

2140MHz Application Schematic

1240 MHz Demo Board

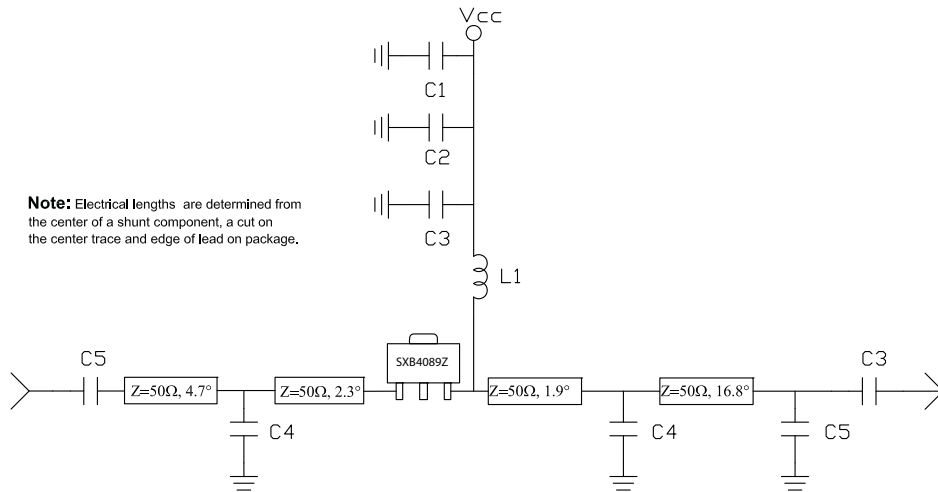

Bill of Materials

- C1 1x TAJB104KLRH Rohm 0.1uF
- C2 1x MCH185C102KK Rohm 1000pF
- C3 2x MCH185A220JK Rohm 22pF
- C4 2x MCH185A1R5CK Rohm 1.5pF
- C5 2x MCH185A1R0CK Rohm 1.0pF
- L1 1x 0805HQ- Coilcraft 20nH
- RF1 2x 142-0701-846 Johnson Comp.
- Heat sink EEF-101216
- PCB ECB-101499 C

2140MHz Evaluation Board Layout

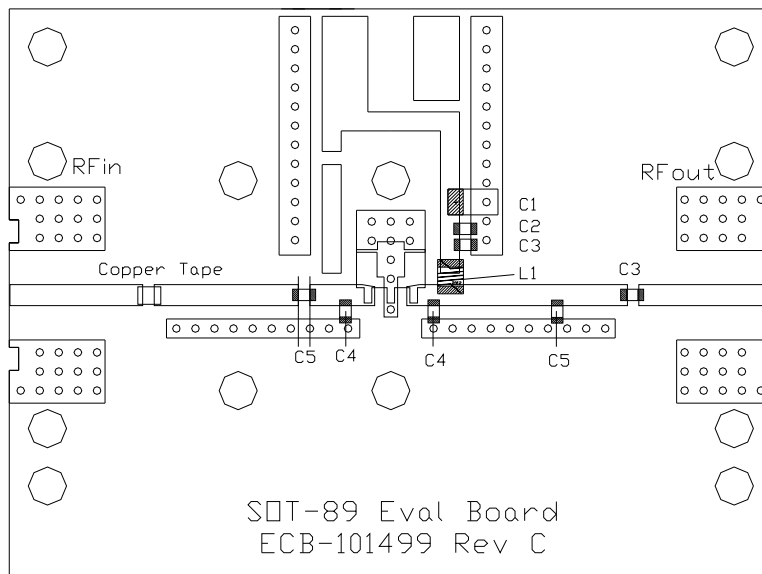

Part Identification

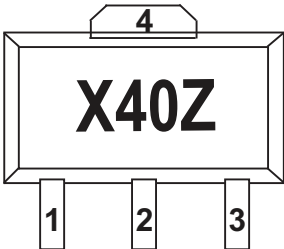

Alternate marking: "SXB4089Z" on line 1 with Trace Code on line 2.

Ordering Information

Ordering Code	Description
SXB4089Z	7" Reel with 1000 pieces
SXB4089ZSQ	Sample bag with 25 pieces
SXB4089ZSR	7" Reel with 100 pieces
SXB4089Z-EVB1	880MHz, 5V Operation PCBA
SXB4089Z-EVB2	1960MHz, 5V Operation PCBA
SXB4089Z-EVB3	2140MHz, 5V Operation PCBA